

#1

Are these shapes congruent?

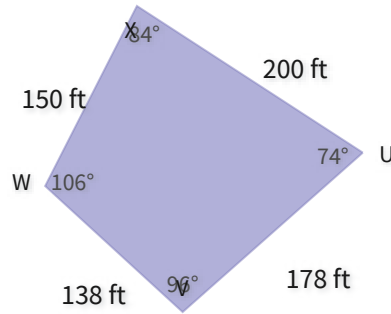
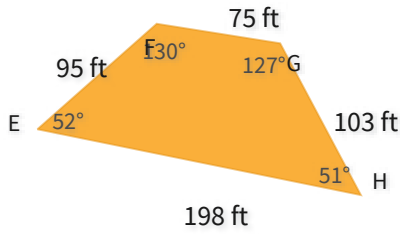

Yes

No

Show your work

#2

Are these shapes congruent?

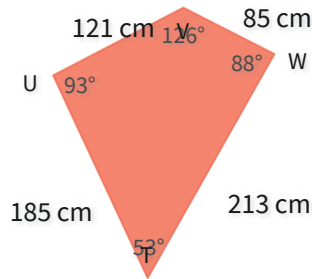
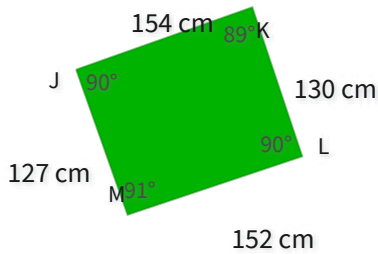

Yes

No

Show your work

#3

Are these shapes similar?

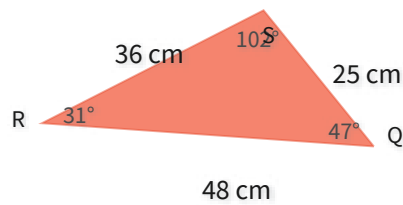
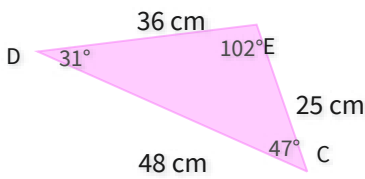

No

Yes

Show your work

#4

Are these shapes similar?

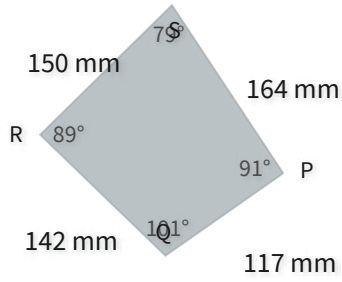
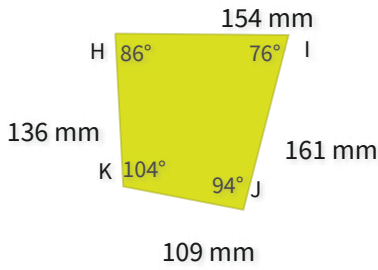

Yes

No

Show your work

#5

Are these shapes similar?

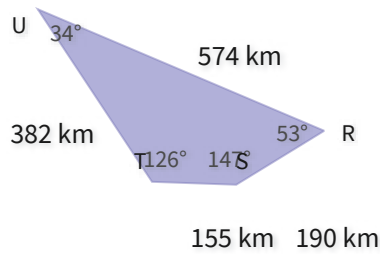
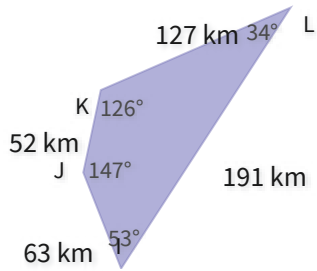

No

Yes

Show your work

#6

Are these shapes congruent?

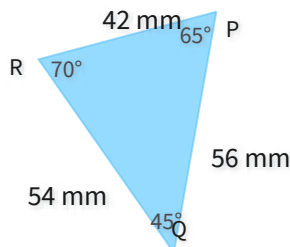
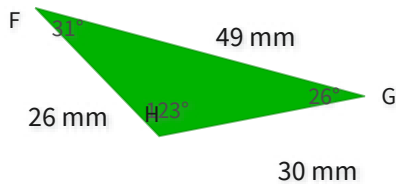

Yes

No

Show your work

#7

Are these shapes congruent?

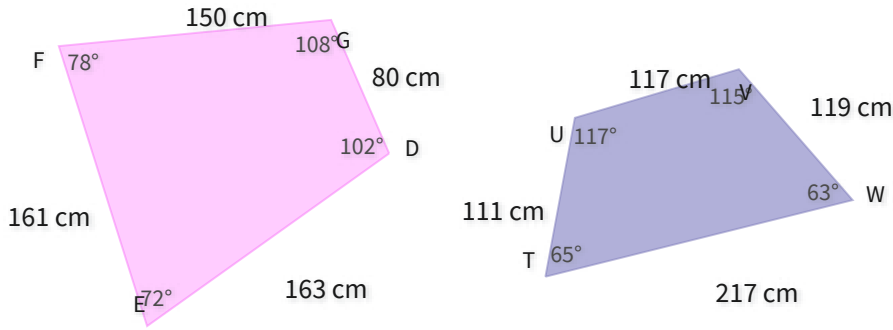

No

Yes

Show your work

#8

Are these shapes similar?

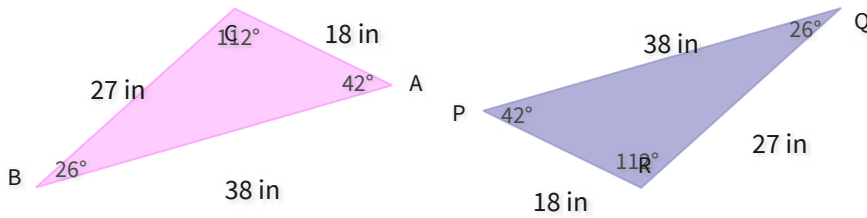

No

Yes

Show your work

#9

Are these shapes similar?

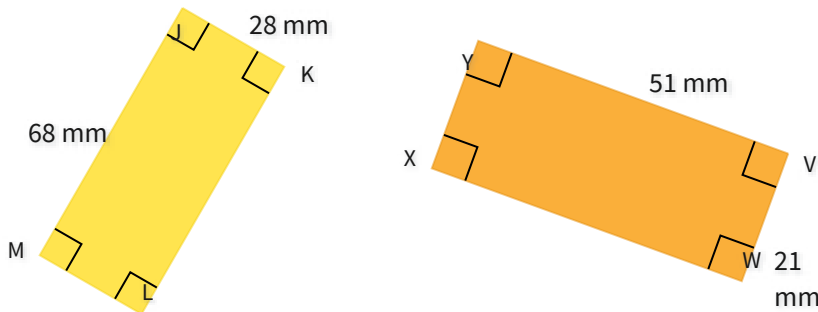

No

Yes

Show your work

#10

Are these shapes similar?

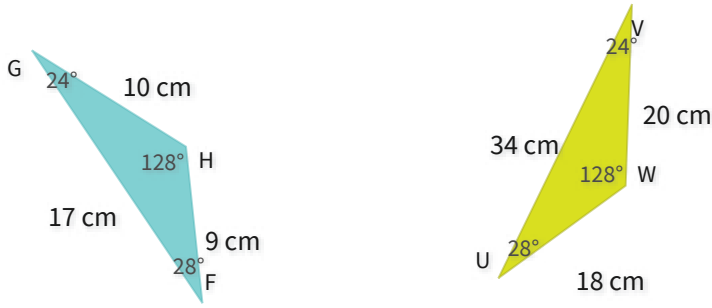

No

Yes

Show your work

#11

Are these shapes congruent?

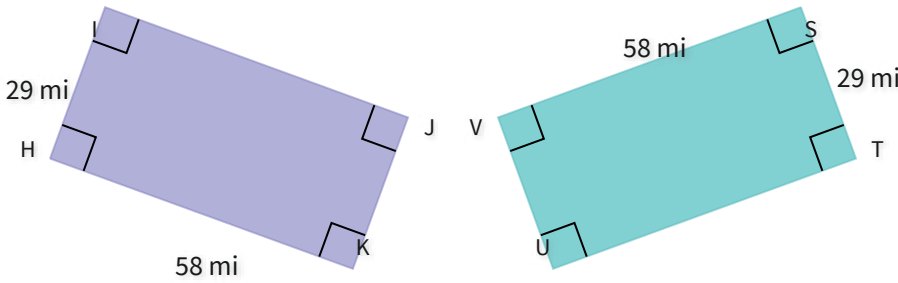

No

Yes

Show your work

#12

Are these shapes similar?

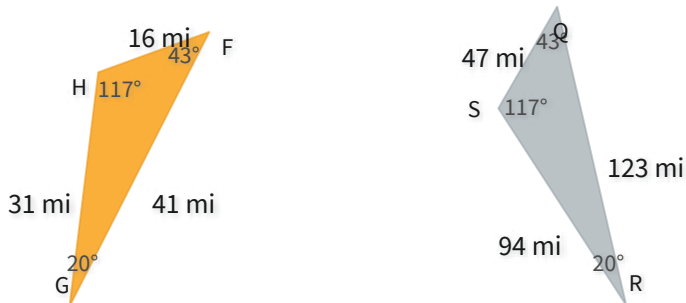

Yes

No

Show your work

Question	Answer
#1	choice 2
#2	choice 2
#3	choice 2
#4	choice 2
#5	choice 2
#6	choice 2
#7	choice 1
#8	choice 2
#9	choice 2
#10	choice 2
#11	choice 2
#12	choice 1